

TA-AX500

US Model
AEP Model
UK Model
E Model

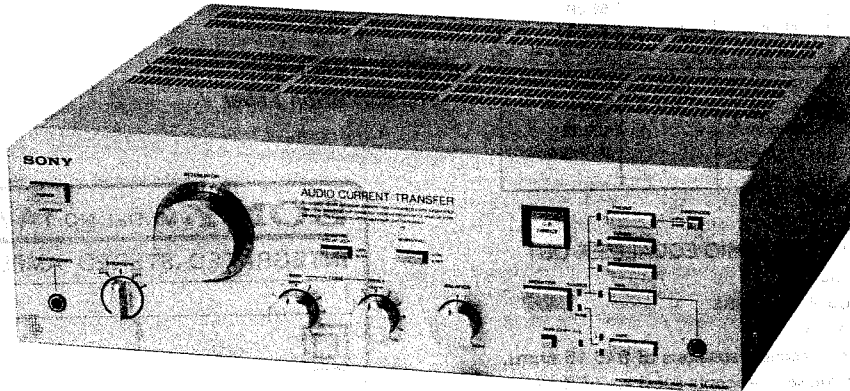

INTEGRATED STEREO AMPLIFIER

SPECIFICATIONS

Amplifier section

Audio Power Specifications

US model:

Power output and total harmonic distortion:
With 8 ohm loads, both channels driven, from
20–20,000 Hz; rated 80 watts per channel
minimum RMS power, with no more than
0.008% total harmonic distortion from 250
milliwatts to rated output.

Continuous RMS power output

AEP model	UK model	E model
90 + 90 watts (1 kHz, 0.008% THD, at 8 ohms)	100 + 100 watts (1 kHz, 0.008% THD, at 6 ohms)	Music power: 300 watts (1 kHz, 0.1% THD, at 6 ohms)
80 + 80 watts (20 Hz–20 kHz, 0.008% THD, at 8 ohms)	80 + 80 watts (20 Hz–20 kHz, 0.008% THD, at 8 ohms)	100 + 100 watts (1 kHz, 0.008% THD, at 6 ohms)
80 + 80 watts (According to DIN 45500, 0.008% THD, at 8 ohms)		80 + 80 watts (20 Hz–20 kHz, 0.008% THD, at 8 ohms)

Power bandwidth (IHF)

5 Hz–50 kHz (40 watts output, 8 ohms,
0.02% THD)

Dynamic headroom

1.8 dB (8 ohms, '78 IHF)

Harmonic distortion

Less than 0.008% at rated output (8 ohms)

Intermodulation (IM) distortion

Less than 0.008% at rated output (8 ohms)

Dynamic range

TUNER, AUX, CD, TAPE 1, 2, GRAPHIC
EQUALIZER IN: 120 dB

Channel separation

PHONO MM: 82 dB

Channel separation

TUNER, AUX, CD, TAPE 1, 2, GRAPHIC
EQUALIZER IN: 84 dB

Frequency response

PHONO: RIAA equalization curve ± 0.2 dB

TUNER, AUX, CD, TAPE 1, 2, GRAPHIC
EQUALIZER IN:

5 Hz–100 kHz ± 0.3 dB (AEP model)

5 Hz–150 kHz ± 0.3 dB (UK, E, US models)

Residual noise

Less than 25 μ V (8 ohms, network A)

Damping factor

50 (8 ohms, 1 kHz)

— Continued on page 2 —

SAFETY-RELATED COMPONENT WARNING!!

COMPONENTS IDENTIFIED BY SHADING AND MARK
ON THE SCHEMATIC DIAGRAMS AND IN THE
PARTS LIST ARE CRITICAL TO SAFE OPERATION.
REPLACE THESE COMPONENTS WITH SONY PARTS
WHOSE PART NUMBERS APPEAR AS SHOWN IN THIS
MANUAL OR IN SUPPLEMENTS PUBLISHED BY SONY.



SONY

SERVICE MANUAL

TA-AX500

Inputs

	Setting of the CARTRIDGE switch	Sensitivity	Impedance	Maximum input capability (1 kHz)	S/N (weighting network, input level)
PHONO	MM	2.5 mV	50 k ohm	150 mV	88 dB 86 dB * (A, 2.5 mV)
	MC	170 μ V	100 ohm	8 mV	68 dB 75 dB * (A, 170 μ V)
TUNER, AUX, CD TAPE 1, 2 GRAPHIC EQUALIZER IN	—	150 mV	50 k ohm	—	98 dB 100 dB * (A, 150 mV)

* '78 IHF

Outputs

REC OUT 1, 2, GRAPHIC EQUALIZER OUT
Voltage 150 mV

Impedance 4.7 k ohms

SPEAKER A, B

AEP model: Accepts speakers of 8 to 16 ohms.

US, UK, E model: Accepts speakers of 6 to 16 ohms.

HEADPHONES

Accepts low and high impedance headphones.

Tone controls

BASS

± 10 dB at 60 Hz (turnover freq. 300 Hz)

TREBLE

± 8 dB at 25 kHz (turnover freq. 5 kHz)

Subsonic filter

6 dB/octave attenuation below 15 Hz

General System

Integrated stereo amplifier

Power amplifier section

Legato linear, pure-complementary, SEPP OCL dc power amplifier with all stages direct coupled

Preamplifier section

Equalizer section: Low-noise high-gain equalizer amp

Audio Current Transfer section: Bridge-balance type voltage-to-current converter

FET buffer power supply

Power requirements

US model:

120 V ac, 60 Hz

AEP model:

220 V ac (or 240 V ac adjustable by authorized Sony personnel), 50/60 Hz

UK model:

240 V ac (or 220 V ac adjustable by authorized Sony personnel), 50/60 Hz

E model:

120, 220 or 240 V ac adjustable, 50/60 Hz

Power consumption

US model: 162 watts

AEP, E model: 200 watts

UK model: 170 watts

AC outlets

AEP model: 1 switched, 100 watts max.

US, E model: 2 switched, total 100 watts max.
1 unswitched, 100 watts max.

Dimensions

Approx. 430 x 130 x 365 mm (w/h/d)
(17 x 5 $\frac{1}{8}$ x 14 $\frac{3}{8}$ inches)

including projecting parts and controls

Weight

Approx. 11 kg (24 lbs 5 oz) net

Approx. 12.4 kg (27 lbs 6 oz) in shipping carton

*Specification values are measured at 30 dB attenuator, except those of residual noise and inputs.

MODEL IDENTIFICATION

— Specification Label —

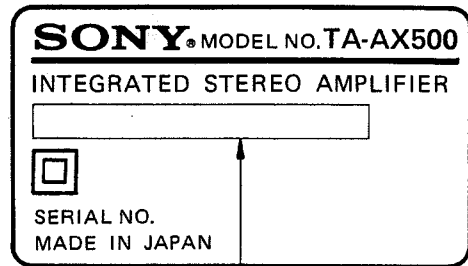

US model: AC 120 V 60 Hz 162 W

AEP model: AC 220 V 50/60 Hz 200 W

UK model: AC 240 V 50/60 Hz 170 W

E model: AC 120, 220 or 240 V 50/60 Hz 200 W

FEATURES

Audio current drive amplifier

An unusual current transfer circuit design keeps the preamplifier and power amplifier stages electrically separate, thus equaling the quality of separate amplifiers.

Legato linear power amplifier stage

The operation of the power amplifier stage is stable without any observable distortion up through the higher frequencies. We call this power amplifier "legato linear", because its switching distortion is very low and its output waveform smooth.

Wide dynamic range of 120 dB

The use of Audio Current Transfer technique and legato linear power amplifier stage has made the amplifier's dynamic range as wide as 120 dB in actual use. This assures high-quality reproduction of digital audio sources.

CD DIRECT switch for pure CD sound reproduction

When you press the CD DIRECT switch, all circuits which are not necessary for CD playback are bypassed and you can enjoy pure digital sound.

Accepts either of the two types of cartridge

The high-gain equalizer amplifier stage using low-noise transistors accepts both moving-coil and moving-magnet cartridges.

SAFETY CHECK-OUT (US Model)

After correcting the original service problem, perform the following safety check before releasing the set to the customer:

Check the antenna terminals, metal trim, "metallized" knobs, screws, and all other exposed metal parts for AC leakage. Check leakage as described below.

LEAKAGE TEST

The AC leakage from any exposed metal part to earth ground and from all exposed metal parts to any exposed metal part having a return to chassis, must not exceed 0.5 mA (500 microampers). Leakage current can be measured by any one of three methods.

1. A commercial leakage tester, such as the Simpson 229 or RCA WT-540A. Follow the manufacturers' instructions to use these instruments.
2. A battery-operated AC milliammeter. The Data Precision 245 digital multimeter is suitable for this job.
3. Measuring the voltage drop across a resistor by means of a VOM or battery-operated AC voltmeter. The "limit" indication is 0.75 V, so analog meters must have an accurate low-voltage scale. The Simpson 250 and Sanwa SH-63Trd are examples of a passive VOM that is suitable. Nearly all battery operated digital multimeters that have a 2 V AC range are suitable. (See Fig. A)

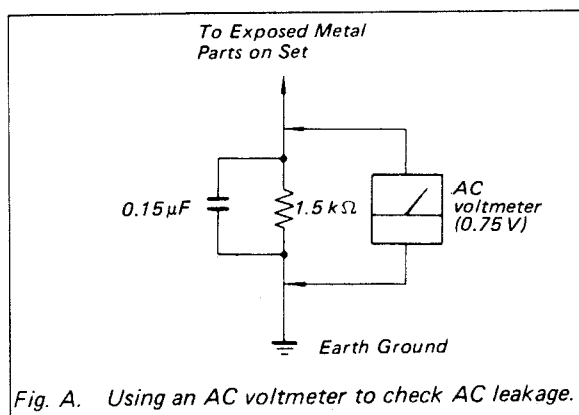
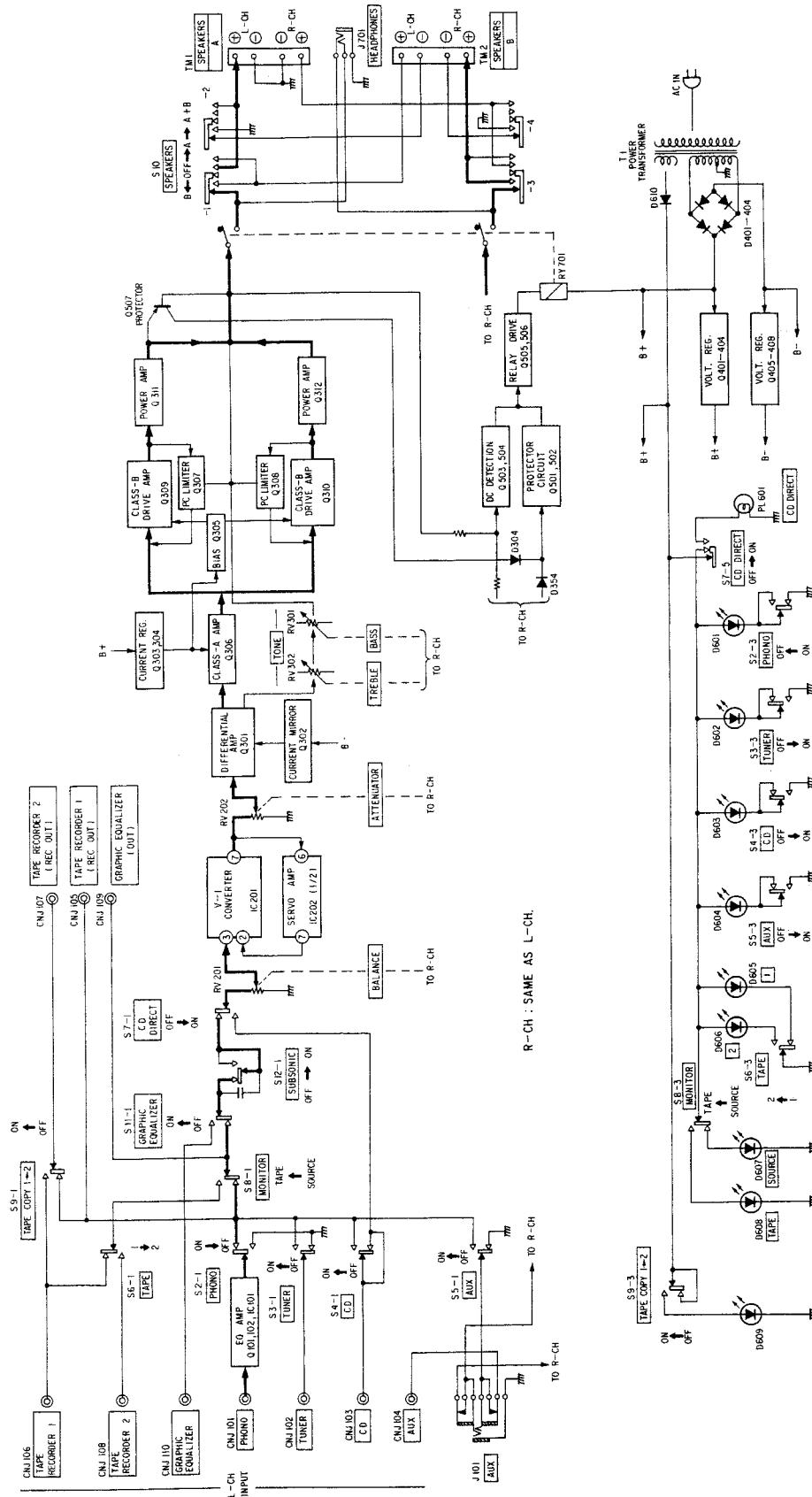

Fig. A. Using an AC voltmeter to check AC leakage.

SECTION 1 OUTLINE

1-1. BLOCK DIAGRAM



**SECTION 2
DISASSEMBLY**

CASE REMOVAL

Remove case by taking out four screws securing case.

BOTTOM CASE REMOVAL

Remove bottom case by loosening eleven BVTT 3 x 6 securing bottom case.

JOINT BAND REMOVAL

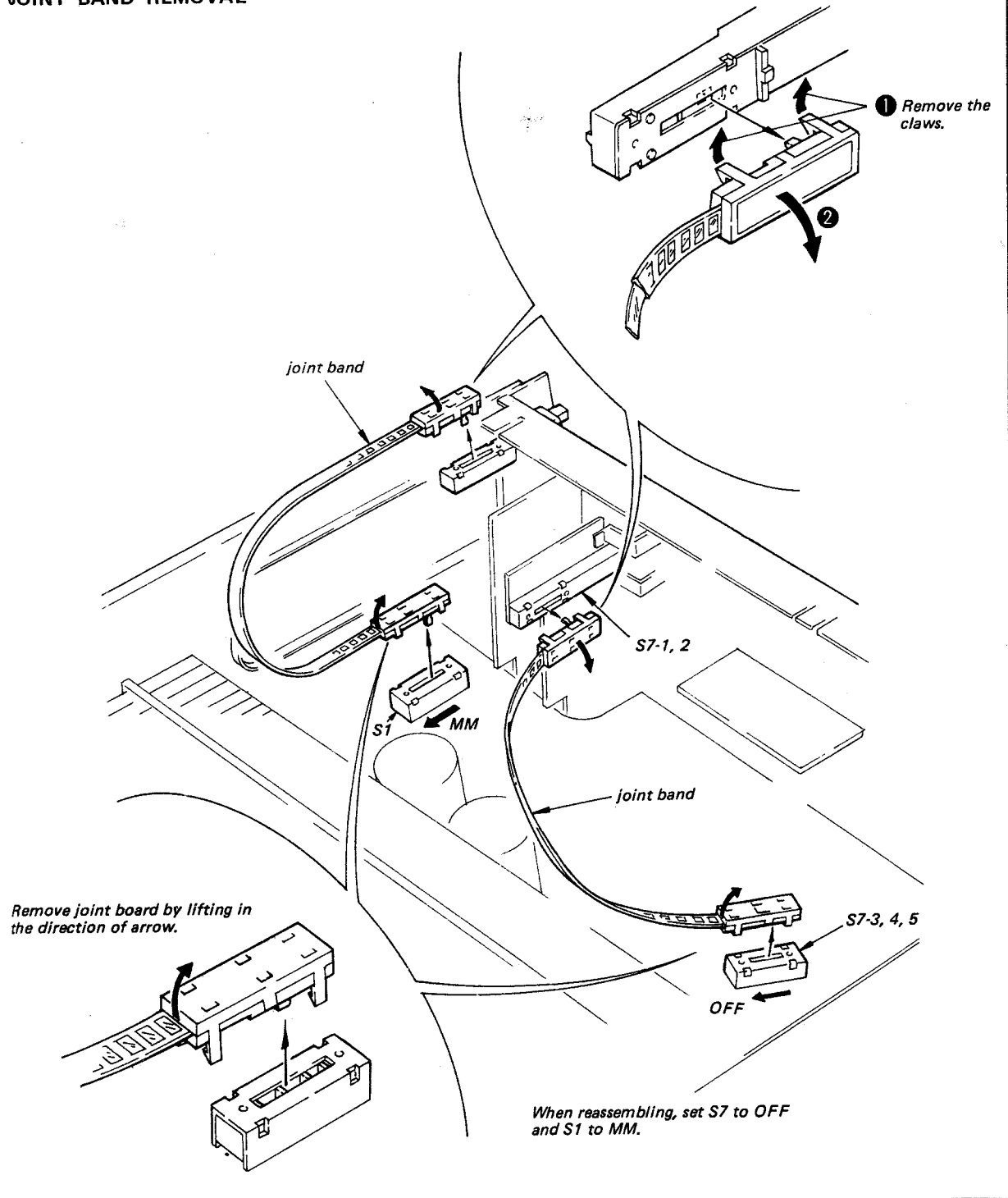

SECTION 3 ADJUSTMENTS

3-1. ELECTRICAL ADJUSTMENTS

Note:

1. DC BIAS and DC BALANCE adjustments should be made several minutes after the POWER switch is turned on (POWER ON.).
2. Make DC BIAS adjustment first.
3. Repeat DC BIAS and DC BALANCE adjustments two or three times.
4. After replacing the power transistor, DC BIAS and DC BALANCE adjustment should be made.

DC Bias Adjustment (with no signal input)

Procedure:

Adjust RT301 (L-CH) and RT351 (R-CH) for 5 mV reading on the VOM.

Adjustment Location:

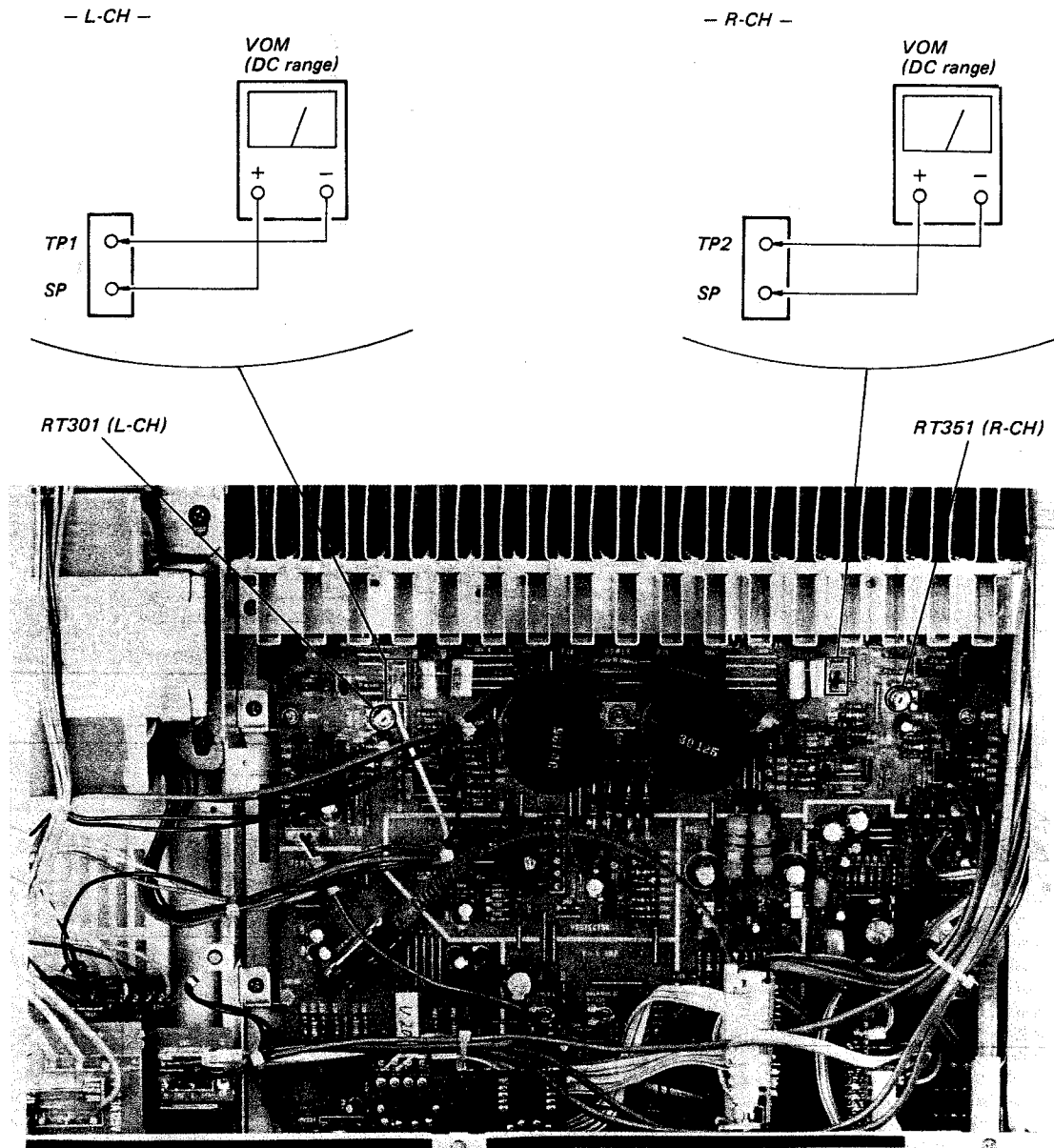

DC Balance Adjustment (with no signal input)

SETTING:

ATTENUATOR knob: MAX

Procedure:

Adjust RT201 (L-CH) and RT251 (R-CH) for 0 mV reading on the VOM.

Adjustment Location:

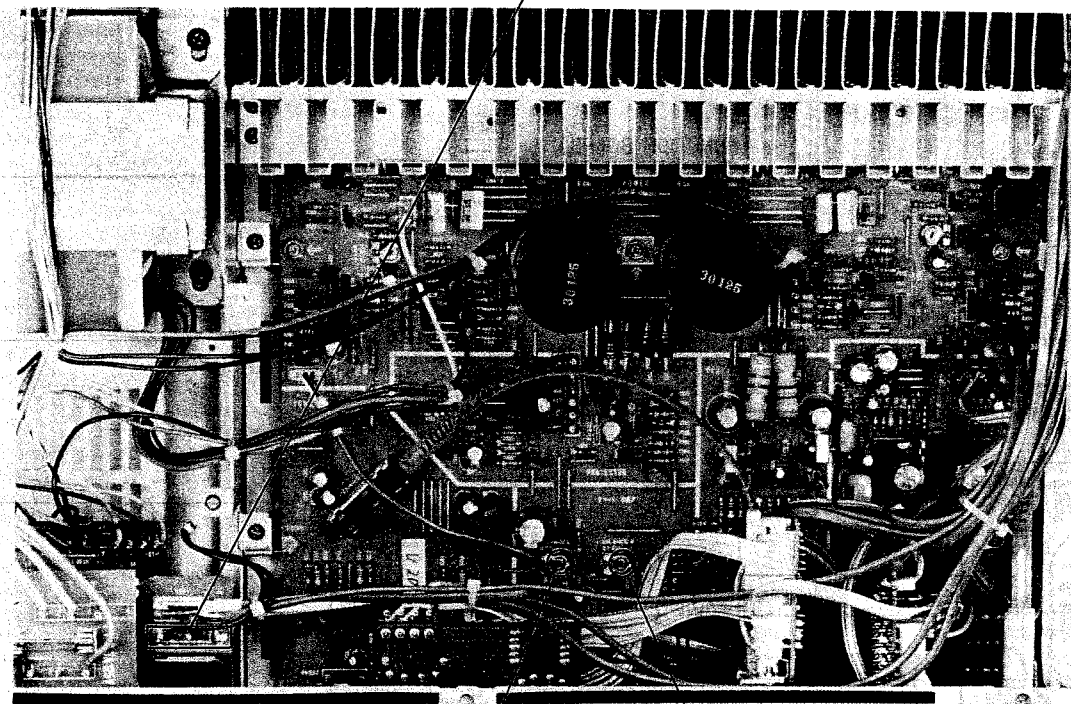
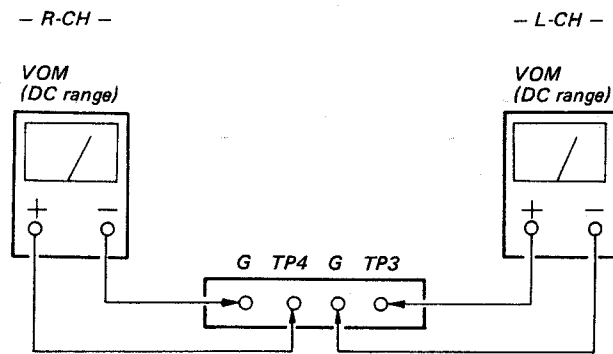

RT201
(L-CH)

RV251
(R-CH)

SECTION 4 DIAGRAMS

4-1. MOUNTING DIAGRAM —Power Supply Section — — Conductor Side —

• See page 9 for notes.

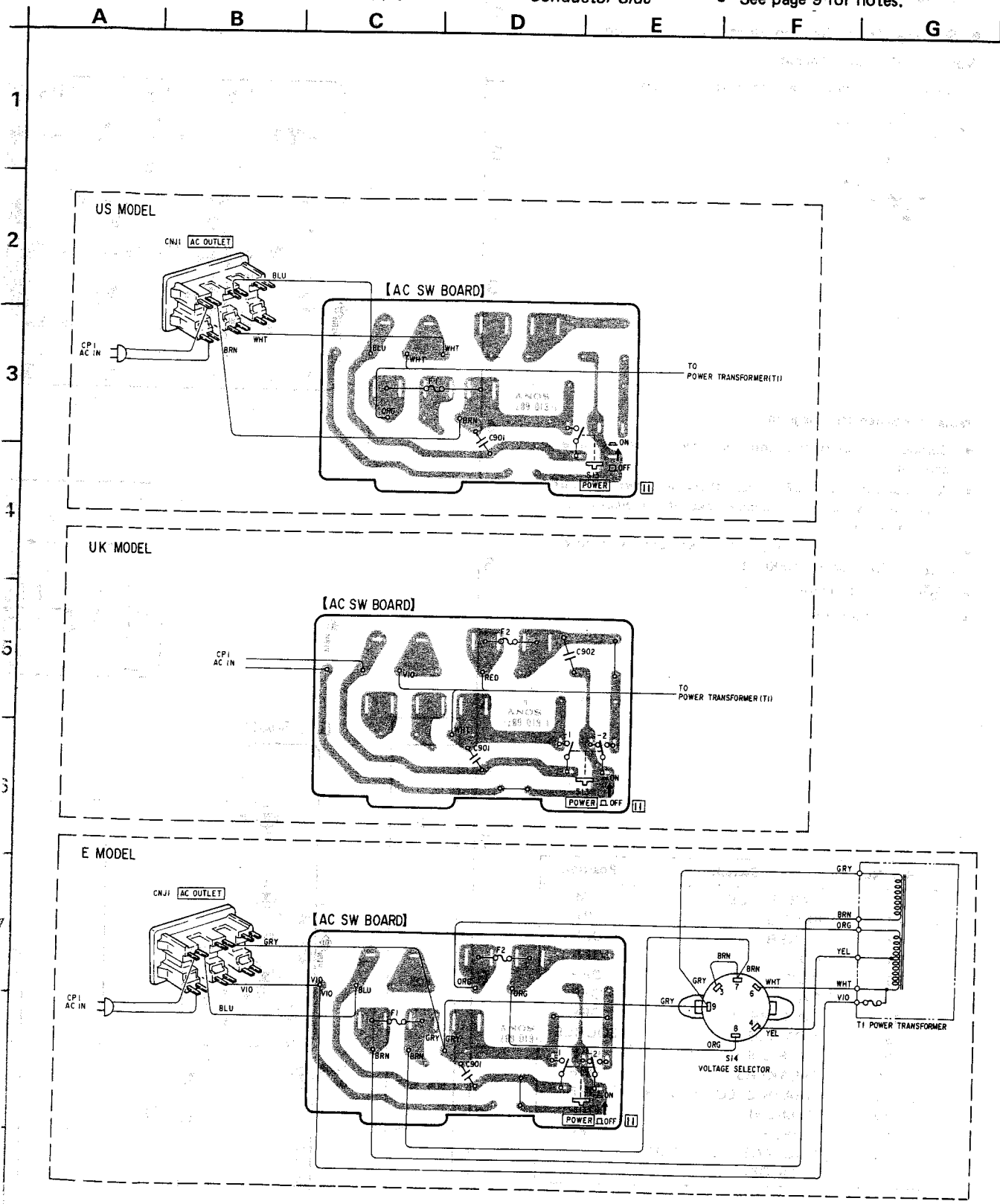

4-2. MOUNTING DIAGRAM

• See page 8 for mounting diagram of primary-side power supply section for US, UK, E model.

• See page 18 for Semiconductor Lead Layouts.

Note: for Mounting Diagram

• Color code of sleeving over the end of the jacket.

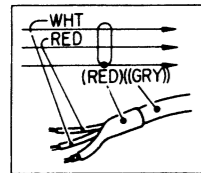

- : B+ pattern
- : B- pattern
- : signal path
- : L-CH signal path
- : R-CH signal path

Note: for Schematic Diagram

- Components for right channel have same values as for left channel.
- All capacitors are in μF unless otherwise noted. pF : μF 50WV or less are not indicated except for electrolytics and tantalums.
- All resistors are in ohms, $\frac{1}{4}\text{W}$ unless otherwise noted. $\text{k}\Omega$: 1000 Ω , $\text{M}\Omega$: 1000 $\text{k}\Omega$
- : nonflammable resistor.
- : signal path
- : adjustment for repair.
- : B+ bus.
- : B- bus.
- Voltages are dc with respect to ground unless otherwise noted.
- Readings are taken under no-signal conditions with a VOM.
- Voltage variations may be noted due to normal production tolerances.
- Switch

Ref. No.	Switch	Position
S1	CARTRIDGE	MM
S2	PHONO	ON
S3	TUNER	OFF
S4	CD	OFF
S5	AUX	OFF
S6	TAPE	OFF
S7	CD DIRECT	OFF
S8	MONITOR	SOURCE
S9	TAPE COPY 1 \rightarrow 2	OFF
S10	SPEAKERS	OFF
S11	GRAPHIC EQUALIZER	OFF
S12	SUBSONIC	OFF
S13	POWER	OFF
S14	VOLTAGE SELECTOR (E MODEL)	

Note: The components identified by shading and mark are critical for safety. Replace only with part number specified.

Note: Voltages are measured with a VOM (50k Ω /V).

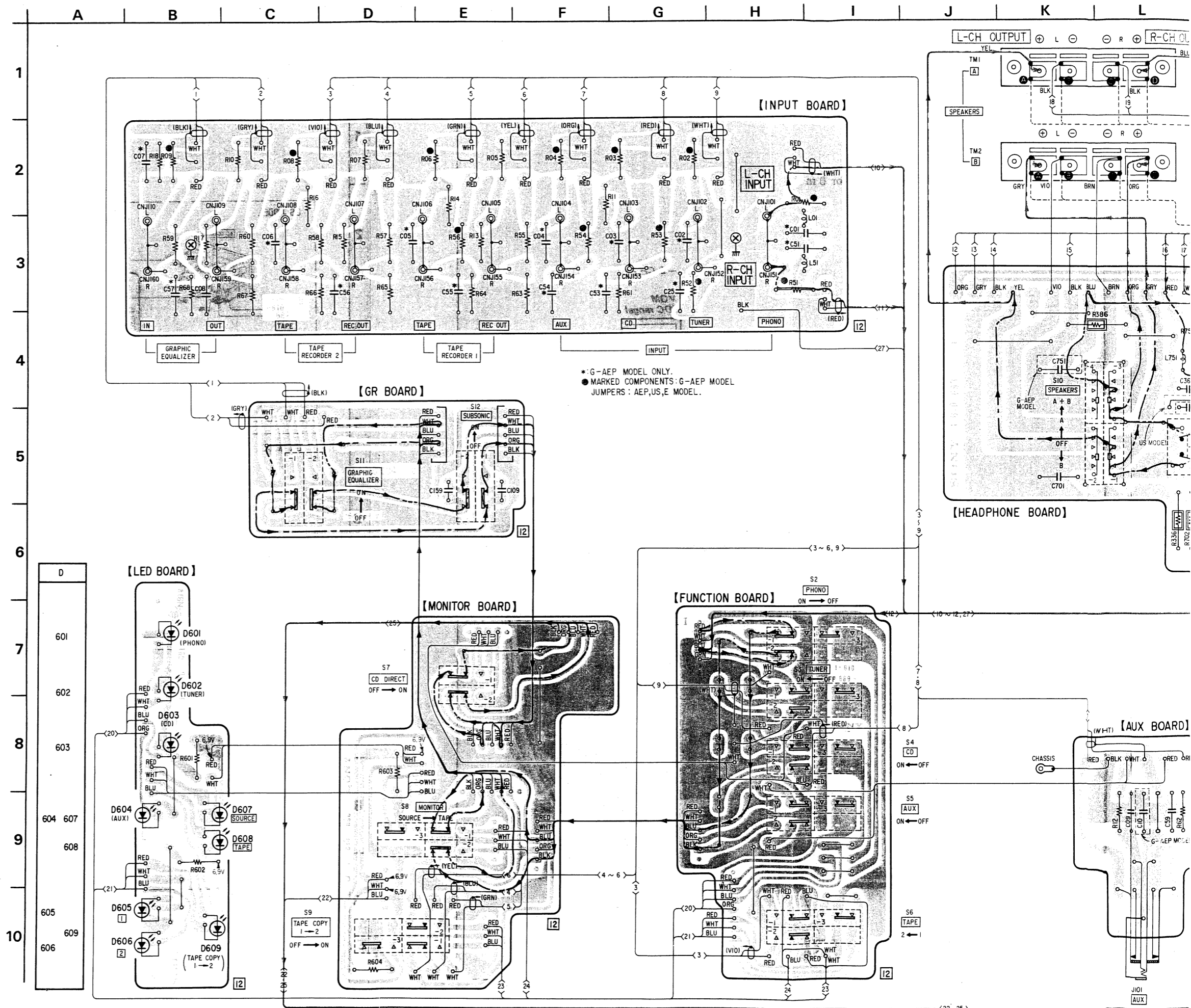

4.3. SCHEMATIC DIAGRAM

• See page 9 for notes. • See page 17 for schematic diagram of primary-side power supply section for US, UK, E model.

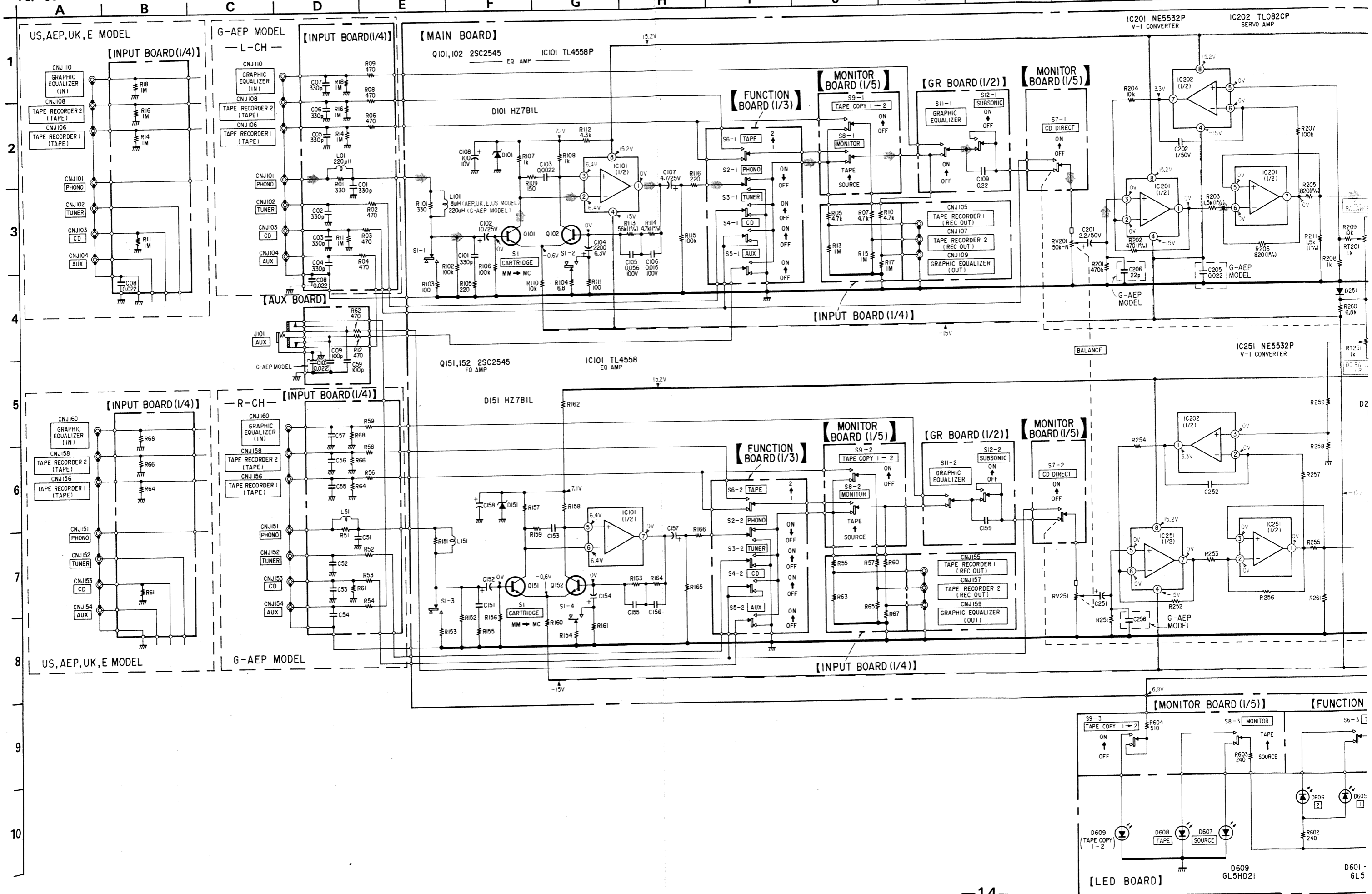

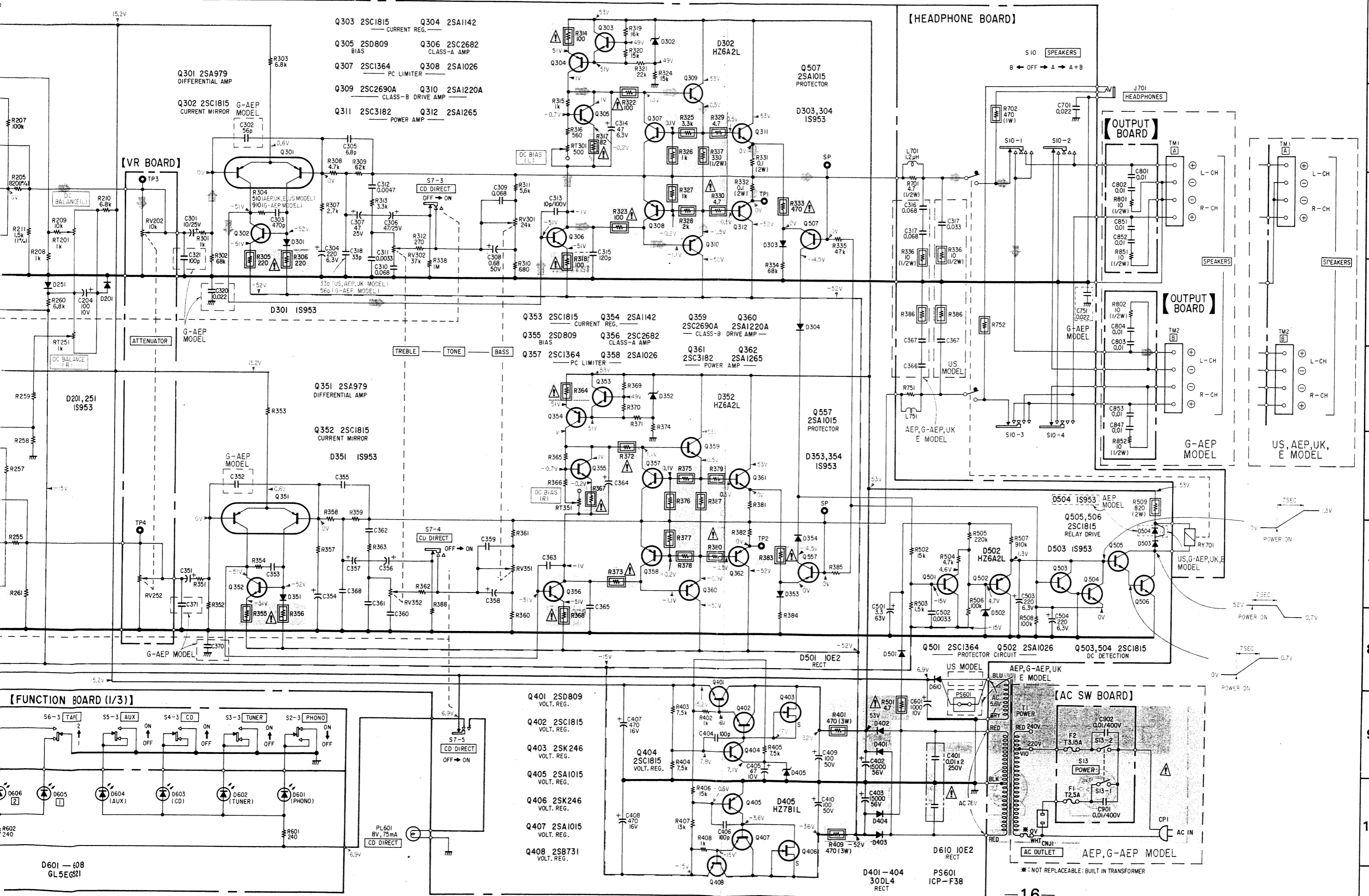

1
2
3
4
5
6
7
8
9
10
11

4.4. SCHEMATIC DIAGRAM – Power Supply Section – • See page 9 for notes.

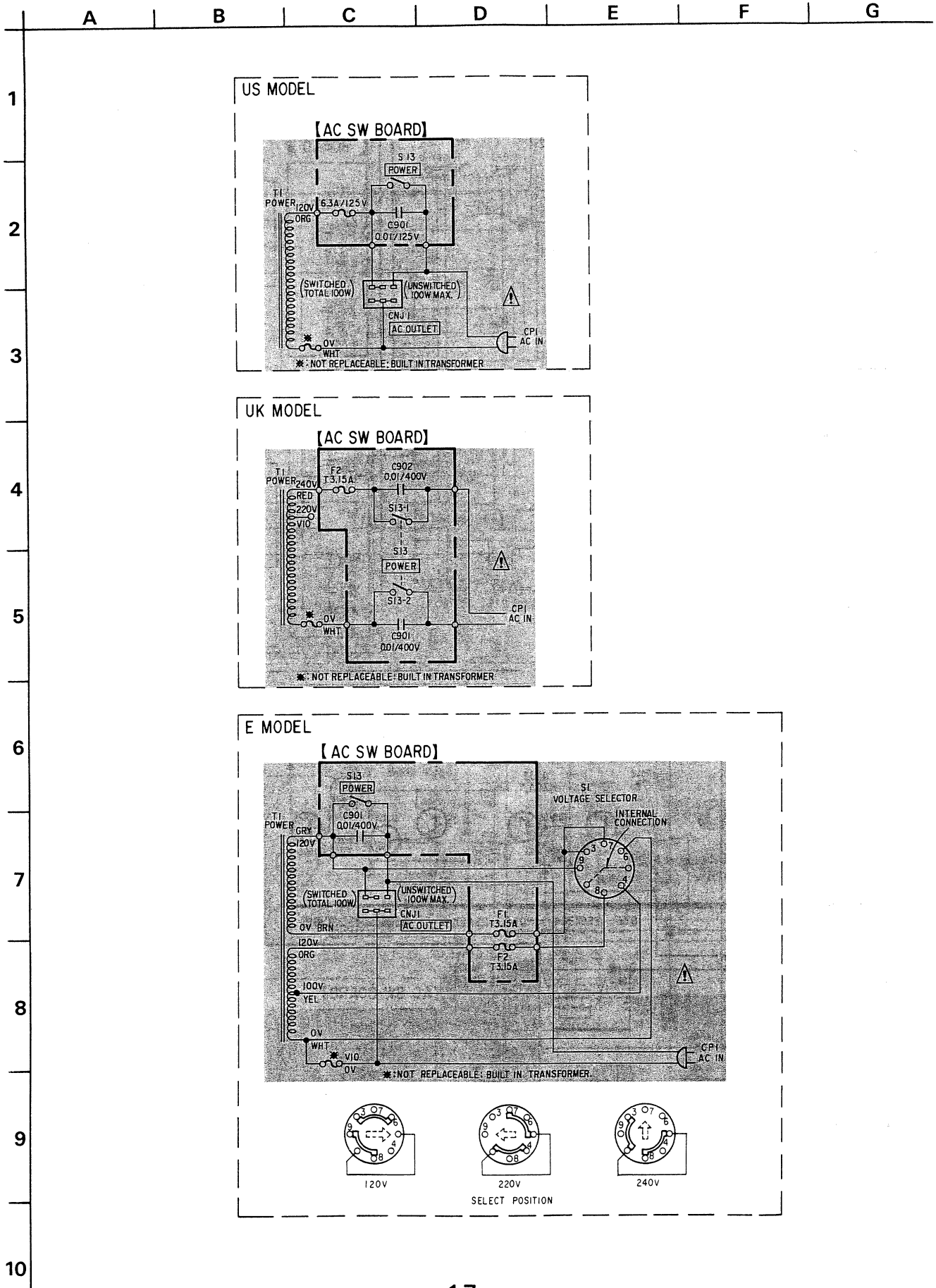

● Semiconductor Lead Layouts

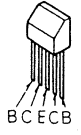
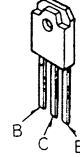
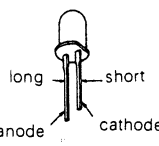
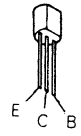
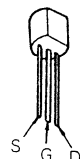
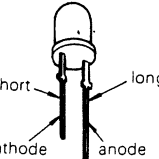
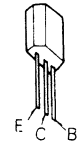
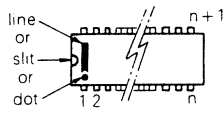
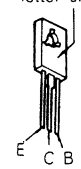
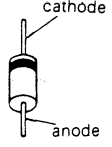
<p>2SA979</p> 	<p>2SA1265 2SC3182</p> 	<p>GL5HD21</p> 
<p>2SA1015 2SC1364 2SC1815-GR 2SC2545</p> 	<p>2SK246</p> 	<p>GL5EG521-B</p> 
<p>2SA1026-7</p> 	<p>NE5532P TL082CP TL4558P-B</p>  <p>(Top view)</p>	
<p>2SA1142 2SA1220A 2SB731 2SC2682 2SC2690A-Q 2SD809</p> <p>letter side</p> 	<p>10E2 30DL4 1S953-7 HZ6A2L HZ7B1L</p> 	

SECTION 5
EXPLODED VIEWS AND PARTS LIST

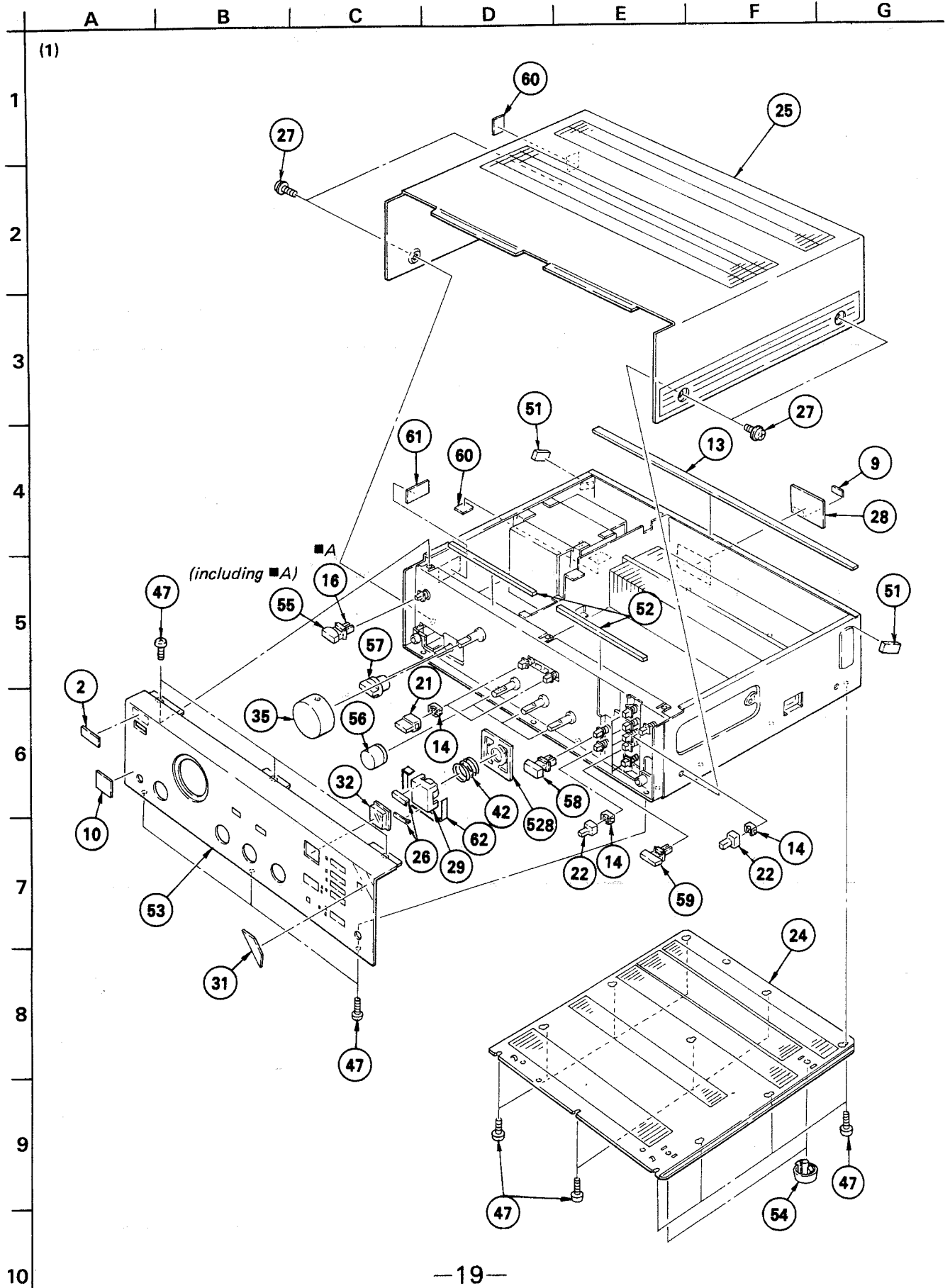

TA-AX500

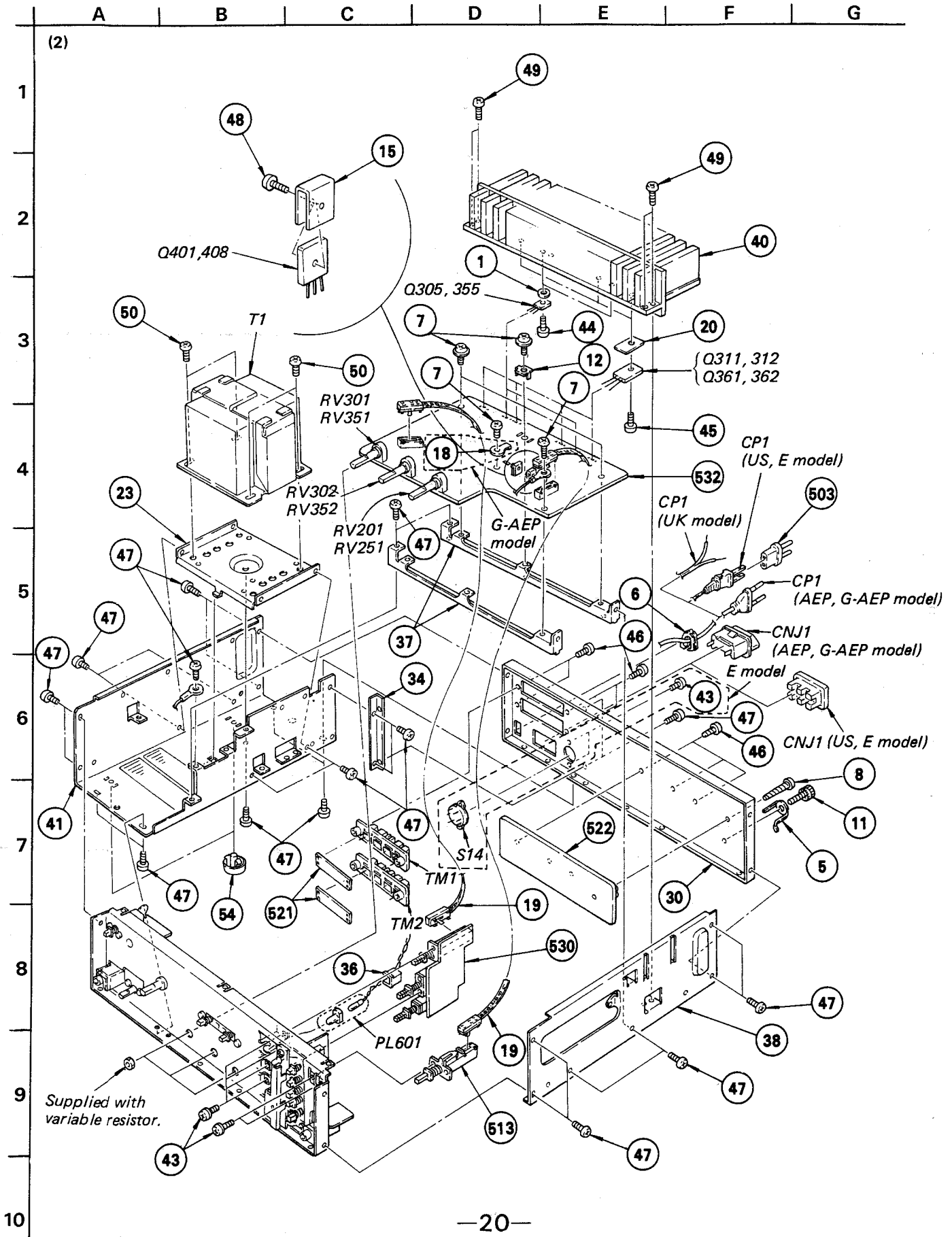

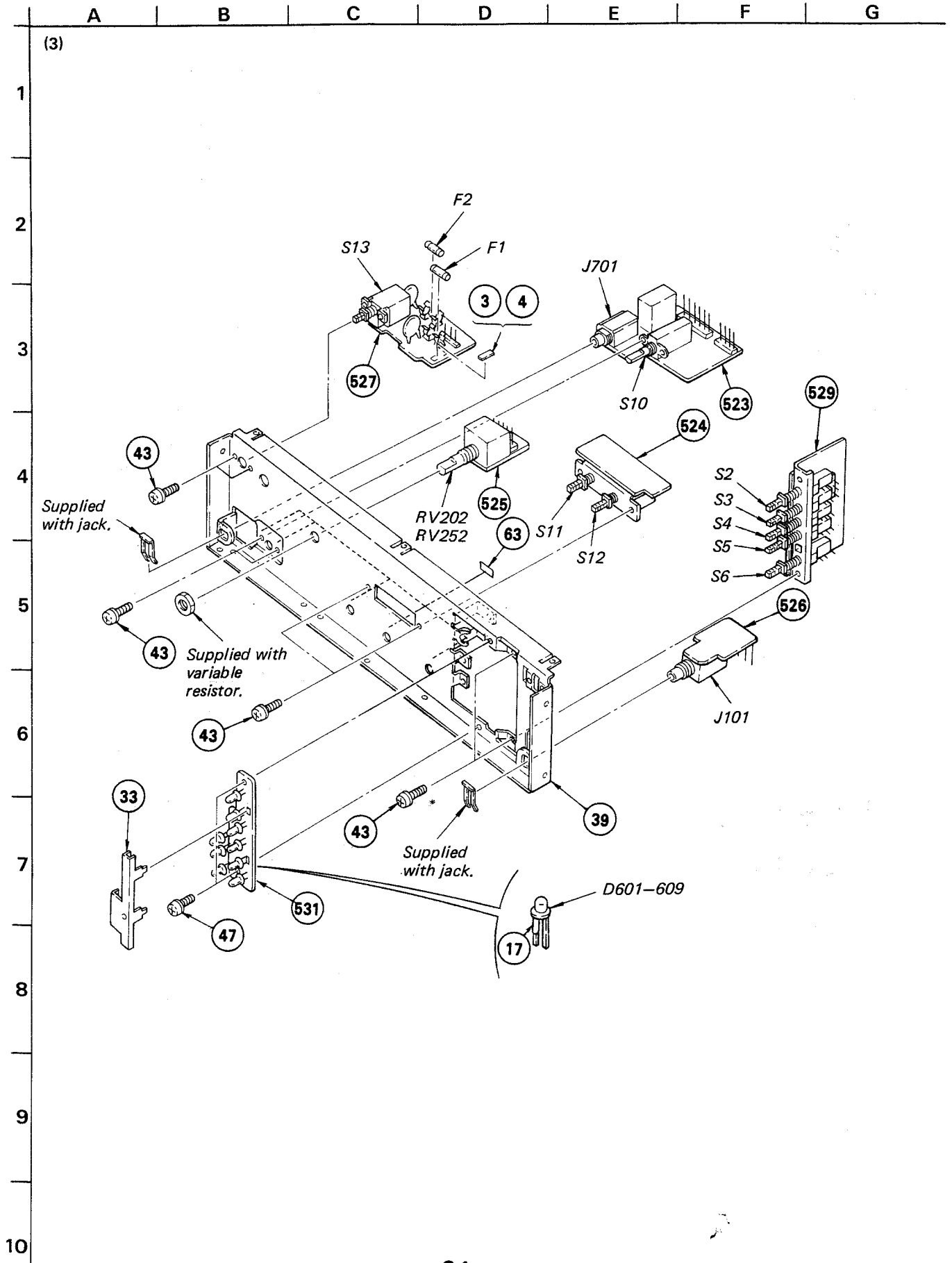

GENERAL SECTION

No.	Part No.	Description
1	3-572-365-01	SHEET (A), INSULATING
2	3-701-690-00	(UK).....LABEL, MADE IN JAPAN
3	3-701-948-18	(AEP,G-AEP)...LABEL, FUSE
4	3-701-948-19	(E).....LABEL, FUSE
5	3-701-993-00	SPACER, TERMINAL
6	3-703-244-00	(AEP,G-AEP,UK)...BUSHING, CORD
6	3-703-571-00	(US,E).....BUSHING, CORD
7	3-703-249-01	SCREW, S TIGHT, +PTWH 3X6
8	3-703-473-00	SCREW, TERMINAL
9	3-703-591-02	(G-AEP)....LABEL (23585S) (SMALL), FTZ
10	3-703-710-01	STICKER, SONY SYMBOL (12)
11	3-706-165-00	SCREW
12	4-835-639-00	PLATE, GROUND
13	4-848-642-00	CUSHION, VIBRATION
14	4-864-307-00	RING
15	4-866-080-00	HEAT SINK
16	4-866-342-00	JOINT (B), KNOB
17	4-866-397-00	CUSHION, LED
18	4-870-539-00	(G-AEP)....PLATE, GROUND
19	4-873-753-21	BAND, JOINT
20	4-875-726-00	SHEET, INSULATING
21	4-881-704-91	KNOB, SQUARE (5X16)
22	4-881-705-11	KNOB (5X6), SQUARE
23	4-885-916-00	BRACKET, TRANSFORMER
24	4-885-922-00	PLATE, BOTTOM
25	4-885-927-11	CASE
26	4-886-031-00	CHIP, ADHESIVE
27	4-889-321-01	SCREW
28	4-889-802-00	(US).....LABEL, MODEL NUMBER
28	4-889-804-00	(AEP,G-AEP)...LABEL, MODEL NUMBER
28	4-889-805-00	(UK).....LABEL, MODEL NUMBER
28	4-889-806-00	(E).....LABEL, MODEL NUMBER
29	4-889-808-00	JOINT, CD
30	4-889-810-01	(US).....PLATE, JACK
30	4-889-810-11	(AEP,G-AEP)....PLATE, JACK
30	4-889-810-21	(UK).....PLATE, JACK
30	4-889-810-31	(E).....PLATE, JACK
31	4-889-813-00	STICKER (C)
32	4-889-814-00	KNOB, CD
33	4-889-815-00	BRACKET, LED
34	4-889-819-00	BRACKET
35	4-889-820-00	KNOB (DIA. 48), R H
36	4-889-823-00	JOINT, KNOB
37	4-889-824-00	CHANNEL
38	4-889-826-00	PLATE, SIDE, RIGHT
39	4-889-827-00	PANEL, SUB

NOTE:

- Items with no part number and no description are not stocked because they are seldom required for routine service.
- Items marked " * " are not stocked since they are seldom required for routine service. Some delay should be anticipated when ordering these items.
- Due to standardization, parts with part numbers (Δ-ΔΔΔ-ΔΔΔ-XX or Δ-ΔΔΔΔ-ΔΔΔ-X) may be different from those used in the set.

CAPACITORS:

MF:μF, PF:μμF.

RESISTORS

- All resistors are in ohms.
- F : nonflammable

COILS

- MMH : mH, UH : μH

SEMICONDUCTORS

In each case, U : μ, for example:
 UA...: μA..., UPA...: μPA..., UPC...: μPC,
 UPD...: μPD...

GENERAL SECTION

No.	Part No.	Description
40	4-889-828-00	HEAT SINK
41	4-889-829-00	PLATE, SIDE, LEFT
42	4-889-830-00	SPRING, COMPRESSION
43	7-682-647-01	SCREW +PS 3X6
44	7-682-649-01	SCREW +PS 3X10
45	7-682-950-01	SCREW +PSW 3X12
46	7-685-646-11	SCREW +BVTP 3X8 TYPE2 N-S
47	7-685-871-01	SCREW +BVTT 3X6 (S)
48	7-685-872-01	SCREW +BVTT 3X8 (S)
49	7-685-873-01	SCREW +BVTT 3X10 (S)
50	7-685-880-01	SCREW +BVTT 4X6 (S)
51	9-911-841-XX	CUSHION
52	9-911-845-XX	CUSHION
53	A-4322-525-A	PANEL ASSY
54	X-4864-303-0	FOOT ASSY
55	X-4886-102-0	KNOB ASSY, POWER C
56	X-4889-801-0	KNOB (DIA. 24) ASSY, R D
57	X-4889-802-0	KNOB ASSY, SPEAKER E
58	X-4889-803-0	KNOB ASSY, SQUARE C
59	X-4889-804-0	KNOB ASSY, SQUARE C
60	3-703-680-00	(US)...LABEL, CAUTION, SUB, NEW UL
61	3-703-044-26	(US)...LABEL, CAUTION
62	4-889-835-00	SLIDER (A)
63	9-911-863-XX	SPACER

ACCESSORY & PACKING MATERIAL

No.	Part No.	Description
101	3-701-630-00	BAG, POLYETHYLENE
102	3-703-390-00	(US)... INSTRUCTION, IMPORTANT
103	3-773-497-11	(AEP,UK,E)...MANUAL, INSTRUCTION
104	3-773-497-21	(US).....MANUAL, INSTRUCTION
105	3-773-497-41	(AEP,G-AEP)...MANUAL, INSTRUCTION F
106	4-858-078-00	SHEET, PROTECTION
107	4-885-931-00	CUSHION, RIGHT
108	4-885-932-00	CUSHION, LEFT
109	4-885-933-00	CUSHION, UPPER
110	4-889-831-00	CARTON

ELECTRICAL PARTS

Ref.No.	Part No.	Description
501	♣;1-508-810-00	14MM BASE POST
502	♣;1-508-811-00	BASE POST (14MM) 4P
503	♣;1-526-565-00	(E1)...ADAPTOR, AC PLUG
504	1-533-131-00	HOLDER, FUSE
505	♣;1-535-115-00	TERMINAL
506	♣;1-535-116-00	TERMINAL
507	♣;1-535-117-00	TERMINAL
508	♣;1-535-119-00	TERMINAL
509	♣;1-535-121-00	TERMINAL
510	♣;1-535-139-00	BASE POST 19MM (10MM PITCH)
511	♣;1-535-141-00	BASE POST 19MM (10MM PITCH)
512	♣;1-535-416-00	TERMINAL
513	1-554-549-00	SWITCH, PUSH S1 (CARTRIDGE) DRIVE
514	♣;1-560-063-00	PIN, CONNECTOR 5P
515	♣;1-560-063-21	PIN, CONNECTOR 5P
516	♣;1-560-063-31	PIN, CONNECTOR 5P
517	♣;1-562-249-00	SOCKET, CONNECTOR 4P
518	♣;1-562-250-00	SOCKET, CONNECTOR 5P
519	♣;1-562-327-00	SOCKET, CONNECTOR 3P
520	♣;1-562-328-00	SOCKET, CONNECTOR 7P
521	♣;1-607-763-00	(G-AEP)...PC BOARD, OUT PUT
522	♣;1-610-682-00	PC BOARD, INPUT
523	♣;1-610-683-00	PC BOARD, HEADPHONE
524	♣;1-610-684-00	PC BOARD, GR
525	♣;1-610-685-00	PC BOARD, VR
526	♣;1-610-686-00	PC BOARD, AUX
527	♣;1-610-687-00	PC BOARD, AC SWITCH
528	♣;1-610-688-00	PC BOARD, STOPPER
529	♣;1-610-689-00	PC BOARD, FUNCTION
530	♣;1-610-690-00	PC BOARD, MONITOR
531	♣;1-610-691-00	PC BOARD, LED
532	♣;A-4388-353-A	(US).....MOUNTED PCB, MAIN
532	♣;A-4388-354-A	(AEP,UK,E)...MOUNTED PCB, MAIN
532	♣;A-4388-355-A	(G-AEP).....MOUNTED PCB, MAIN
C01	1-161-317-00	(G-AEP)...CERAMIC 330PF 10% 50V
C02	1-161-317-00	(G-AEP)...CERAMIC 330PF 10% 50V
C03	1-161-317-00	(G-AEP)...CERAMIC 330PF 10% 50V
C04	1-161-317-00	(G-AEP)...CERAMIC 330PF 10% 50V
C05	1-161-317-00	(G-AEP)...CERAMIC 330PF 10% 50V
C06	1-161-317-00	(G-AEP)...CERAMIC 330PF 10% 50V
C07	1-161-317-00	(G-AEP)...CERAMIC 330PF 10% 50V
C08	1-161-494-00	CERAMIC 0.022MF 30% 25V
C09	1-161-271-00	CERAMIC 100PF 5% 50V
C10	1-161-494-00	(G-AEP)...CERAMIC 0.022MF 30% 25V
C51	1-161-317-00	(G-AEP)...CERAMIC 330PF 10% 50V
C52	1-161-317-00	(G-AEP)...CERAMIC 330PF 10% 50V

ELECTRICAL PARTS

Ref.No.	Part No.	Description
C53	1-161-317-00	(G-AEP)...CERAMIC 330PF 10% 50V
C54	1-161-317-00	(G-AEP)...CERAMIC 330PF 10% 50V
C55	1-161-317-00	(G-AEP)...CERAMIC 330PF 10% 50V
C56	1-161-317-00	(G-AEP)...CERAMIC 330PF 10% 50V
C57	1-161-317-00	(G-AEP)...CERAMIC 330PF 10% 50V
C59	1-161-271-00	CERAMIC 100PF 5% 50V
C101	1-161-317-00	CERAMIC 330PF 10% 50V
C102	1-123-356-00	ELECT 10MF 20% 25V
C103	1-161-326-00	CERAMIC 0.0022MF 30% 50V
C104	1-123-300-00	ELECT 2200MF 20% 6.3V
C105	1-130-765-00	FILM 0.056MF 2% 100V
C106	1-130-764-00	FILM 0.016MF 2% 100V
C107	1-123-328-00	ELECT 4.7MF 20% 25V
C108	1-123-307-00	ELECT 100MF 20% 10V
C109	1-130-636-00	FILM 0.22MF 5% 50V
C151	1-161-317-00	CERAMIC 330PF 10% 50V
C152	1-123-356-00	ELECT 10MF 20% 25V
C153	1-161-326-00	CERAMIC 0.0022MF 30% 50V
C154	1-123-300-00	ELECT 2200MF 20% 6.3V
C155	1-130-765-00	FILM 0.056MF 2% 100V
C156	1-130-764-00	FILM 0.016MF 2% 100V
C157	1-123-328-00	ELECT 4.7MF 20% 25V
C158	1-123-307-00	ELECT 100MF 20% 10V
C159	1-130-636-00	FILM 0.22MF 5% 50V
C201	1-123-353-00	ELECT 2.2MF 20% 50V
C202	1-124-182-00	ELECT 1MF 20% 50V
C204	1-123-307-00	ELECT 100MF 20% 10V
C205	1-161-494-00	(G-AEP)...CERAMIC 0.022MF 30% 25V
C206	1-161-263-00	(G-AEP)...CERAMIC 22PF 5% 50V
C251	1-123-353-00	ELECT 2.2MF 20% 50V
C252	1-124-182-00	ELECT 1MF 20% 50V
C256	1-161-263-00	(G-AEP)...CERAMIC 22PF 5% 50V
C301	1-123-356-00	ELECT 10MF 20% 25V
C302	1-161-268-00	(G-AEP)...CERAMIC 56PF 5% 50V
C303	1-161-319-00	CERAMIC 470PF 10% 50V
C304	1-123-296-00	ELECT 220MF 20% 6.3V
C305	1-161-257-00	CERAMIC 6.8PF 10% 50V
C306	1-123-332-00	ELECT 47MF 20% 25V
C307	1-123-332-00	ELECT 47MF 20% 25V
C308	1-123-902-00	ELECT 0.68MF 20% 50V
C309	1-108-599-00	MYLAR 0.068MF 5% 50V
C310	1-108-599-00	MYLAR 0.068MF 5% 50V
C311	1-161-327-00	CERAMIC 0.0033MF 30% 50V
C312	1-161-328-00	CERAMIC 0.0047MF 30% 50V
C313	1-107-279-91	MICA 10PF 0.5PF 100V

NOTE:

- Items with no part number and no description are not stocked because they are seldom required for routine service.
- Items marked "♣" are not stocked since they are seldom required for routine service. Some delay should be anticipated when ordering these items.
- Due to standardization, parts with part numbers (Δ-ΔΔΔ-ΔΔΔ-XX or Δ-ΔΔΔΔ-ΔΔΔ-X) may be different from those used in the set.

CAPACITORS:

MF:μF, PF:μμF.

RESISTORS

All resistors are in ohms.

F: nonflammable

COILS

MMH: mH, UH: μH

SEMICONDUCTORS

In each case, U: μ, for example:

UA...: μA..., UPA...: μPA..., UPC...: μPC,

UPD...: μPD...

The components identified by shading and mark ♣ are critical for safety. Replace only with part number specified.

ELECTRICAL PARTS

Ref.No.	Part No.	Description			
C314	1-123-294-00	ELECT	47MF	20%	6.3V
C315	1-161-272-00	CERAMIC	120PF	5%	50V
C316	1-108-599-00	(AEP,G-AEP,UK,E)...MYLAR	0.068MF	5%	50V
C317	1-108-591-00	(US).....FILM	0.033MF	5%	50V
C317	1-108-599-00	(AEP,G-AEP,UK,E)...MYLAR	0.068MF	5%	50V
C318	1-161-265-00	(US,AEP,UK,E)..CERAMIC	33PF	5%	50V
C318	1-161-268-00	(G-AEP)...CERAMIC	56PF	5%	50V
C320	1-161-494-00	(G-AEP)...CERAMIC	0.022MF	30%	25V
C321	1-161-271-00	(G-AEP)...CERAMIC	100PF	5%	50V
C351	1-123-356-00	ELECT	10MF	20%	25V
C352	1-161-268-00	(G-AEP)...CERAMIC	56PF	5%	50V
C353	1-161-319-00	CERAMIC	470PF	10%	50V
C354	1-123-296-00	ELECT	220MF	20%	6.3V
C355	1-161-257-00	CERAMIC	6.8PF	10%	50V
C356	1-123-332-00	ELECT	47MF	20%	25V
C357	1-123-332-00	ELECT	47MF	20%	25V
C358	1-123-902-00	ELECT	0.68MF	20%	50V
C359	1-108-599-00	MYLAR	0.068MF	5%	50V
C360	1-108-599-00	MYLAR	0.068MF	5%	50V
C361	1-161-327-00	CERAMIC	0.0033MF	30%	50V
C362	1-161-328-00	CERAMIC	0.0047MF	30%	50V
C363	1-107-279-91	MICA	10PF	0.5PF	100V
C364	1-123-294-00	ELECT	47MF	20%	6.3V
C365	1-161-272-00	CERAMIC	120PF	5%	50V
C366	1-108-599-00	(AEP,G-AEP,UK,E)...MYLAR	0.068MF	5%	50V
C367	1-108-591-00	(US).....FILM	0.033MF	5%	50V
C367	1-108-599-00	(AEP,G-AEP,UK,E)...MYLAR	0.068MF	5%	50V
C368	1-161-265-00	(US,AEP,UK,E)..CERAMIC	33PF	5%	50V
C368	1-161-268-00	(G-AEP)...CERAMIC	56PF	5%	50V
C370	1-161-494-00	(G-AEP)...CERAMIC	0.022MF	30%	25V
C371	1-161-271-00	(G-AEP)...CERAMIC	100PF	5%	50V
C401	1-102-394-00	CERAMIC	0.01X2		250V
C402	1-125-346-00	ELECT(BLOCK)	15000MF	99%	56V
C403	1-125-346-00	ELECT(BLOCK)	15000MF	99%	56V
C404	1-161-271-00	CERAMIC	100PF	5%	50V
C405	1-123-306-00	ELECT	47MF	20%	10V
C406	1-161-271-00	CERAMIC	100PF	5%	50V
C407	1-123-323-00	ELECT	470MF	20%	16V
C408	1-123-323-00	ELECT	470MF	20%	16V
C409	1-123-360-00	ELECT	100MF	20%	50V
C410	1-123-360-00	ELECT	100MF	20%	50V
C501	1-123-382-00	ELECT	3.3MF	20%	63V
C502	1-108-567-00	MYLAR	0.0033MF	5%	50V

ELECTRICAL PARTS

Ref.No.	Part No.	Description			
C503	1-123-296-00	ELECT	220MF	20%	6.3V
C504	1-123-296-00	ELECT	220MF	20%	6.3V
C601	1-123-311-00	ELECT	1000MF	20%	10V
C701	1-161-494-00	CERAMIC	0.022MF	30%	25V
C751	1-161-494-00	(G-AEP)...CERAMIC	0.022MF	30%	25V
C801	1-161-330-00	(G-AEP)...CERAMIC	0.01MF	30%	25V
C802	1-161-330-00	(G-AEP)...CERAMIC	0.01MF	30%	25V
C803	1-161-330-00	(G-AEP)...CERAMIC	0.01MF	30%	25V
C804	1-161-330-00	(G-AEP)...CERAMIC	0.01MF	30%	25V
C851	1-161-330-00	(G-AEP)...CERAMIC	0.01MF	30%	25V
C852	1-161-330-00	(G-AEP)...CERAMIC	0.01MF	30%	25V
C853	1-161-330-00	(G-AEP)...CERAMIC	0.01MF	30%	25V
C854	1-161-330-00	(G-AEP)...CERAMIC	0.01MF	30%	25V
C901	1-161-744-00	(AEP,G-AEP,UK,E)...CERAMIC	0.01MF		400V
C901	1-161-749-00	(US).....FILM	0.01MF		125V
C902	1-161-744-00	(AEP,G-AEP,UK,E)...CERAMIC	0.01MF		400V
CNJ1	1-526-574-00	(US,E).....OUTLET, AC			
CNJ1	1-526-694-00	(AEP,G-AEP).....OUTLET, AC			
CNJ101	1-507-741-21	JACK, PIN 6P			
CNJ102	1-507-741-21	JACK, PIN 6P			
CNJ103	1-507-741-21	JACK, PIN 6P			
CNJ104	1-507-740-00	JACK, PIN 4P			
CNJ105	1-507-740-00	JACK, PIN 4P			
CNJ106	1-507-740-00	JACK, PIN 4P			
CNJ107	1-507-740-00	JACK, PIN 4P			
CNJ108	1-507-887-00	JACK, PIN 6P			
CNJ109	1-507-887-00	JACK, PIN 6P			
CNJ110	1-507-887-00	JACK, PIN 6P			
CNJ151	1-507-741-21	JACK, PIN 6P			
CNJ152	1-507-741-21	JACK, PIN 6P			
CNJ153	1-507-741-21	JACK, PIN 6P			
CNJ154	1-507-740-00	JACK, PIN 4P			
CNJ155	1-507-740-00	JACK, PIN 4P			
CNJ156	1-507-740-00	JACK, PIN 4P			
CNJ157	1-507-740-00	JACK, PIN 4P			
CNJ158	1-507-887-00	JACK, PIN 6P			
CNJ159	1-507-887-00	JACK, PIN 6P			
CNJ160	1-507-887-00	JACK, PIN 6P			
CPI	1-534-817-XX	(AEP,G-AEP)....CORD, POWER, EULO PLUG			
CPI	1-551-472-00	(E).....CORD, POWER			
CPI	1-551-628-00	(US).....CORD, POWER			
CPI	1-551-884-00	(UK).....CORD, POWER			

NOTE:

- Items with no part number and no description are not stocked because they are seldom required for routine service.
- Items marked "▲" are not stocked since they are seldom required for routine service. Some delay should be anticipated when ordering these items.
- Due to standardization, parts with part numbers (Δ-ΔΔΔ-ΔΔΔ-XX or Δ-ΔΔΔΔ-ΔΔΔ-X) may be different from those used in the set.

CAPACITORS:

MF:μF, PF:μμF.

RESISTORS

- All resistors are in ohms.
- F : nonflammable

COILS

- MMH : mH, UH : μH

SEMICONDUCTORS

In each case, U : μ, for example:

UA.... : μA...., UPA.... : μPA...., UPC.... : μPC, UPD.... : μPD....

The components identified by shading and mark ▲ are critical for safety. Replace only with part number specified.

ELECTRICAL PARTS

Ref.No.	Part No.	Description
D101	8-719-910-74	DIODE HZ7B1L
D151	8-719-910-74	DIODE HZ7B1L
D201	8-719-107-57	DIODE 1S953-7
D251	8-719-107-57	DIODE 1S953-7
D301	8-719-107-57	DIODE 1S953-7
D302	8-719-910-62	DIODE HZ6A2L
D303	8-719-107-57	DIODE 1S953-7
D304	8-719-107-57	DIODE 1S953-7
D351	8-719-107-57	DIODE 1S953-7
D352	8-719-910-62	DIODE HZ6A2L
D353	8-719-107-57	DIODE 1S953-7
D354	8-719-107-57	DIODE 1S953-7
D401	△ 8-719-230-24	DIODE 30DL4
D402	△ 8-719-230-24	DIODE 30DL4
D403	△ 8-719-230-24	DIODE 30DL4
D404	△ 8-719-230-24	DIODE 30DL4
D405	8-719-910-74	DIODE HZ7B1L
D501	8-719-200-02	DIODE 10E-2
D502	8-719-910-62	DIODE HZ6A2L
D503	8-719-107-57	DIODE 1S953-7
D504	8-719-107-57	(AEP)... DIODE 1S953-7
D601	8-719-907-92	DIODE GL-5EG521-B
D602	8-719-907-92	DIODE GL-5EG521-B
D603	8-719-907-92	DIODE GL-5EG521-B
D604	8-719-907-92	DIODE GL-5EG521-B
D605	8-719-907-92	DIODE GL-5EG521-B
D606	8-719-907-92	DIODE GL-5EG521-B
D607	8-719-907-92	DIODE GL-5EG521-B
D608	8-719-907-92	DIODE GL-5EG521-B
D609	8-719-906-58	DIODE GL-5HD21
D610	8-719-200-02	DIODE 10E-2
F1	△ 1-532-237-00	(E)... FUSE, TIME-LAG 3.15A
F1	△ 1-532-286-00	(AEP,G-AEP)... FUSE, TIME-LAG 2.5A C
F1	△ 1-532-509-00	(US)... FUSE, GALSS TUBE 6.3A
F2	△ 1-532-237-00	(AEP,G-AEP,UK,E)... FUSE, TIME-LAG 3.15A B
IC101	8-759-935-58	IC TL4558P-B C
IC201	8-759-900-72	IC NE5532P E
IC202	8-759-990-82	IC TL082CP G
IC251	8-759-900-72	IC NE5532P
J101	1-507-729-00	JACK, LARGE TYPE, AUX
J701	1-507-669-00	JACK, HEADPHONE
L01	1-413-101-00	(G-AEP)...COIL, INPUT, 220MH
L51	1-413-101-00	(G-AEP)...COIL, INPUT, 220MH
L101	1-407-519-00	(AEP,UK,US,E)...INDUCTOR, 8MH
L101	1-413-101-00	(G-AEP)...COIL, INPUT, 220MH

ELECTRICAL PARTS

Ref.No.	Part No.	Description
L151	1-407-519-00	(AEP,UK,US,E)...INDUCTOR, 8MH
L151	1-413-101-00	(G-AEP)...COIL, INPUT, 220MH
L701	♣;1-420-872-00	COIL, AIR CORE, 1.2MH
L751	♣;1-420-872-00	COIL, AIR CORE, 1.2MH
PL601	1-518-538-00	LAMP, PILOT B
PS601	1-532-675-00	(AEP,G-AEP,UK,E)...LINK, IC
Q101	8-729-354-52	TRANSISTOR 2SC2545
Q102	8-729-354-52	TRANSISTOR 2SC2545
Q151	8-729-354-52	TRANSISTOR 2SC2545
Q152	8-729-354-52	TRANSISTOR 2SC2545
Q301	8-729-697-92	TRANSISTOR 2SA979
Q302	8-729-281-53	TRANSISTOR 2SC1815-GR
Q303	8-729-281-53	TRANSISTOR 2SC1815-GR
Q304	8-729-114-22	TRANSISTOR 2SA1142
Q305	8-729-180-93	TRANSISTOR 2SD809
Q306	8-729-168-22	TRANSISTOR 2SC2682
Q307	8-729-663-47	TRANSISTOR 2SC1364
Q308	8-729-602-67	TRANSISTOR 2SA1026-7
Q309	8-729-102-39	TRANSISTOR 2SC2690A-Q
Q310	8-729-122-02	TRANSISTOR 2SA1220A
Q311	8-729-201-97	TRANSISTOR 2SC3182
Q312	8-729-201-89	TRANSISTOR 2SA1265
Q351	8-729-697-92	TRANSISTOR 2SA979
Q352	8-729-281-53	TRANSISTOR 2SC1815-GR
Q353	8-729-281-53	TRANSISTOR 2SC1815-GR
Q354	8-729-114-22	TRANSISTOR 2SA1142
Q355	8-729-180-93	TRANSISTOR 2SD809
Q356	8-729-168-22	TRANSISTOR 2SC2682
Q357	8-729-663-47	TRANSISTOR 2SC1364
Q358	8-729-602-67	TRANSISTOR 2SA1026-7
Q359	8-729-102-39	TRANSISTOR 2SC2690A-Q
Q360	8-729-122-02	TRANSISTOR 2SA1220A
Q361	8-729-201-97	TRANSISTOR 2SC3182
Q362	8-729-201-89	TRANSISTOR 2SA1265
Q401	8-729-180-93	TRANSISTOR 2SD809
Q402	8-729-281-53	TRANSISTOR 2SC1815-GR
Q403	8-729-224-61	TRANSISTOR 2SK246
Q404	8-729-281-53	TRANSISTOR 2SC1815-GR
Q405	8-729-201-52	TRANSISTOR 2SA1015
Q406	8-729-224-61	TRANSISTOR 2SK246
Q407	8-729-201-52	TRANSISTOR 2SA1015
Q408	8-729-173-13	TRANSISTOR 2SB731
Q501	8-729-663-47	TRANSISTOR 2SC1364
Q502	8-729-602-67	TRANSISTOR 2SA1026-7
Q503	8-729-281-53	TRANSISTOR 2SC1815-GR

NOTE:

- Items with no part number and no description are not stocked because they are seldom required for routine service.
- Items marked "♣" are not stocked since they are seldom required for routine service. Some delay should be anticipated when ordering these items.
- Due to standardization, parts with part numbers (△-△△△-△△△-XX or △-△△△△-△△△-X) may be different from those used in the set.

CAPACITORS:

MF:μF, PF:μμF.

RESISTORS

• All resistors are in ohms.

• F : nonflammable

COILS

• MMH : mH, UH : μH

SEMICONDUCTORS

In each case, U : μ, for example:

UA...: μA..., UPA...: μPA..., UPC...: μPC,

UPD...: μPD...

The components identified by shading and mark △ are critical for safety. Replace only with part number specified.

ELECTRICAL PARTS

Ref.No.	Part No.	Description				
Q504	8-729-281-53	TRANSISTOR 2SC1815-GR				
Q505	8-729-281-53	TRANSISTOR 2SC1815-GR				
Q506	8-729-281-53	TRANSISTOR 2SC1815-GR				
Q507	8-729-201-52	TRANSISTOR 2SA1015				
Q557	8-729-201-52	TRANSISTOR 2SA1015				
R01	1-246-461-00	(G-AEP)...CARBON	330	5%	1/4W	
R02	1-246-465-00	(G-AEP)...CARBON	470	5%	1/4W	
R03	1-246-465-00	(G-AEP)...CARBON	470	5%	1/4W	
R04	1-246-465-00	(G-AEP)...CARBON	470	5%	1/4W	
R05	1-246-489-00	CARBON 4.7K	5%	1/4W		
R06	1-246-465-00	(G-AEP)...CARBON	470	5%	1/4W	
R07	1-246-489-00	CARBON 4.7K	5%	1/4W		
R08	1-246-465-00	(G-AEP)...CARBON	470	5%	1/4W	
R09	1-246-465-00	(G-AEP)...CARBON	470	5%	1/4W	
R10	1-246-489-00	CARBON 4.7K	5%	1/4W		
R11	1-246-545-00	CARBON 1M	5%	1/4W		
R12	1-246-465-00	CARBON 470	5%	1/4W		
R13	1-246-545-00	CARBON 1M	5%	1/4W		
R14	1-246-545-00	CARBON 1M	5%	1/4W		
R15	1-246-545-00	CARBON 1M	5%	1/4W		
R16	1-246-545-00	CARBON 1M	5%	1/4W		
R17	1-246-545-00	CARBON 1M	5%	1/4W		
R18	1-246-545-00	CARBON 1M	5%	1/4W		
R51	1-246-461-00	(G-AEP)...CARBON	330	5%	1/4W	
R52	1-246-465-00	(G-AEP)...CARBON	470	5%	1/4W	
R53	1-246-465-00	(G-AEP)...CARBON	470	5%	1/4W	
R54	1-246-465-00	(G-AEP)...CARBON	470	5%	1/4W	
R55	1-246-489-00	CARBON 4.7K	5%	1/4W		
R56	1-246-465-00	(G-AEP)...CARBON	470	5%	1/4W	
R57	1-246-489-00	CARBON 4.7K	5%	1/4W		
R58	1-246-465-00	(G-AEP)...CARBON	470	5%	1/4W	
R59	1-246-465-00	(G-AEP)...CARBON	470	5%	1/4W	
R61	1-246-545-00	CARBON 1M	5%	1/4W		
R62	1-246-465-00	CARBON 470	5%	1/4W		
R63	1-246-545-00	CARBON 1M	5%	1/4W		
R64	1-246-545-00	CARBON 1M	5%	1/4W		
R65	1-246-545-00	CARBON 1M	5%	1/4W		
R66	1-246-545-00	CARBON 1M	5%	1/4W		
R67	1-246-545-00	CARBON 1M	5%	1/4W		
R68	1-246-545-00	CARBON 1M	5%	1/4W		
R101	1-246-461-00	CARBON 330	5%	1/4W		
R102	1-246-521-00	CARBON 100K	5%	1/4W		
R103	1-246-449-00	CARBON 100	5%	1/4W		
R104	1-246-421-00	CARBON 6.8	5%	1/4W		

ELECTRICAL PARTS

Ref.No.	Part No.	Description				
R105	1-246-457-00	CARBON 220	5%	1/4W		
R106	1-246-521-00	CARBON 100K	5%	1/4W		
R107	1-246-473-00	CARBON 1K	5%	1/4W		
R108	1-246-473-00	CARBON 1K	5%	1/4W		
R109	1-246-453-00	CARBON 150	5%	1/4W		
R110	1-246-497-00	CARBON 10K	5%	1/4W		
R111	1-246-449-00	CARBON 100	5%	1/4W		
R112	1-246-488-00	CARBON 4.3K	5%	1/4W		
R113	1-214-771-00	METAL 56K	1%	1/4W		
R114	1-214-745-00	METAL 4.7K	1%	1/4W		
R115	1-246-521-00	CARBON 100K	5%	1/4W		
R116	1-246-457-00	CARBON 220	5%	1/4W		
R151	1-246-461-00	CARBON 330	5%	1/4W		
R152	1-246-521-00	CARBON 100K	5%	1/4W		
R153	1-246-449-00	CARBON 100	5%	1/4W		
R154	1-246-421-00	CARBON 6.8	5%	1/4W		
R155	1-246-457-00	CARBON 220	5%	1/4W		
R156	1-246-521-00	CARBON 100K	5%	1/4W		
R157	1-246-473-00	CARBON 1K	5%	1/4W		
R158	1-246-473-00	CARBON 1K	5%	1/4W		
R159	1-246-453-00	CARBON 150	5%	1/4W		
R160	1-246-497-00	CARBON 10K	5%	1/4W		
R161	1-246-449-00	CARBON 100	5%	1/4W		
R162	1-246-488-00	CARBON 4.3K	5%	1/4W		
R163	1-214-771-00	METAL 56K	1%	1/4W		
R164	1-214-745-00	METAL 4.7K	1%	1/4W		
R165	1-246-521-00	CARBON 100K	5%	1/4W		
R166	1-246-457-00	CARBON 220	5%	1/4W		
R201	1-246-537-00	CARBON 470K	5%	1/4W		
R202	1-214-721-00	METAL 470	1%	1/4W		
R203	1-214-733-00	METAL 1.5K	1%	1/4W		
R204	1-246-497-00	CARBON 10K	5%	1/4W		
R205	1-214-727-00	METAL 820	1%	1/4W		
R206	1-214-727-00	METAL 820	1%	1/4W		
R207	1-246-521-00	CARBON 100K	5%	1/4W		
R208	1-246-473-00	CARBON 1K	5%	1/4W		
R209	1-246-497-00	CARBON 10K	5%	1/4W		
R210	1-246-493-00	CARBON 6.8K	5%	1/4W		
R211	1-214-733-00	METAL 1.5K	1%	1/4W		
R251	1-246-537-00	CARBON 470K	5%	1/4W		
R252	1-214-721-00	METAL 470	1%	1/4W		
R253	1-214-733-00	METAL 1.5K	1%	1/4W		
R254	1-246-497-00	CARBON 10K	5%	1/4W		
R255	1-214-727-00	METAL 820	1%	1/4W		
R256	1-214-727-00	METAL 820	1%	1/4W		

NOTE:

- Items with no part number and no description are not stocked because they are seldom required for routine service.
- Items marked " * " are not stocked since they are seldom required for routine service. Some delay should be anticipated when ordering these items.
- Due to standardization, parts with part numbers (Δ-ΔΔΔ-ΔΔΔ-XX or Δ-ΔΔΔΔ-ΔΔΔ-X) may be different from those used in the set.

CAPACITORS:

MF:μF, PF:μμF.

RESISTORS

• All resistors are in ohms.

• F : nonflammable

COILS

• MMH : mH, UH : μH

SEMICONDUCTORS

In each case, U : μ, for example:
 UA... : μA..., UPA... : μPA..., UPC... : μPC,
 UPD... : μPD...

ELECTRICAL PARTS

Ref.No.	Part No.	Description			
R257	1-246-521-00	CARBON	100K	5%	1/4W
R258	1-246-473-00	CARBON	1K	5%	1/4W
R259	1-246-497-00	CARBON	10K	5%	1/4W
R260	1-246-493-00	CARBON	6.8K	5%	1/4W
R261	1-214-733-00	METAL	1.5K	1%	1/4W
R301	1-246-473-00	CARBON	1K	5%	1/4W
R302	1-246-517-00	CARBON	68K	5%	1/4W
R303	1-246-493-00	CARBON	6.8K	5%	1/4W
R304	1-246-472-00	CARBON	910	5%	1/4W
R305	1-247-115-00	CARBON	220	5%	1/4W F
R306	1-247-115-00	CARBON	220	5%	1/4W F
R307	1-246-483-00	CARBON	2.7K	5%	1/4W
R308	1-246-489-00	CARBON	4.7K	5%	1/4W
R309	1-246-516-00	CARBON	62K	5%	1/4W
R310	1-246-469-00	CARBON	680	5%	1/4W
R311	1-246-491-00	CARBON	5.6K	5%	1/4W
R312	1-246-459-00	CARBON	270	5%	1/4W
R313	1-246-485-00	CARBON	3.3K	5%	1/4W
R314	1-247-107-00	CARBON	100	5%	1/4W F
R315	1-246-473-00	CARBON	1K	5%	1/4W
R316	1-246-467-00	CARBON	560	5%	1/4W
R317	1-247-105-00	CARBON	82	5%	1/4W F
R318	1-247-107-00	CARBON	100	5%	1/4W F
R319	1-246-502-00	CARBON	16K	5%	1/4W
R320	1-246-501-00	CARBON	15K	5%	1/4W
R321	1-246-505-00	CARBON	22K	5%	1/4W
R322	1-247-107-00	CARBON	100	5%	1/4W F
R323	1-247-107-00	CARBON	100	5%	1/4W F
R324	1-246-501-00	CARBON	15K	5%	1/4W
R325	1-247-143-00	CARBON	3.3K	5%	1/4W F
R326	1-247-131-00	CARBON	1K	5%	1/4W F
R327	1-247-131-00	CARBON	1K	5%	1/4W F
R328	1-247-138-00	CARBON	2K	5%	1/4W F
R329	1-247-079-00	CARBON	4.7	5%	1/4W F
R330	1-247-079-00	CARBON	4.7	5%	1/4W F
R331	1-217-611-00	RES, METAL PLATE 0.1		2W	
R332	1-217-611-00	RES, METAL PLATE 0.1		2W	
R333	1-247-123-00	CARBON	470	5%	1/4W F
R334	1-246-517-00	CARBON	68K	5%	1/4W
R335	1-246-513-00	CARBON	47K	5%	1/4W
R336	1-247-192-00	CARBON	10	5%	1/2W F
R337	1-247-228-00	CARBON	330	5%	1/2W F
R338	1-246-545-00	CARBON	1M	5%	1/4W
R351	1-246-473-00	CARBON	1K	5%	1/4W
R352	1-246-517-00	CARBON	68K	5%	1/4W
R353	1-246-493-00	CARBON	6.8K	5%	1/4W

ELECTRICAL PARTS

Ref.No.	Part No.	Description			
R354	1-246-472-00	CARBON	910	5%	1/4W
R355	1-247-115-00	CARBON	220	5%	1/4W F
R356	1-247-115-00	CARBON	220	5%	1/4W F
R357	1-246-483-00	CARBON	2.7K	5%	1/4W
R358	1-246-489-00	CARBON	4.7K	5%	1/4W
R359	1-246-516-00	CARBON	62K	5%	1/4W
R360	1-246-469-00	CARBON	680	5%	1/4W
R361	1-246-491-00	CARBON	5.6K	5%	1/4W
R362	1-246-459-00	CARBON	270	5%	1/4W
R363	1-246-485-00	CARBON	3.3K	5%	1/4W
R364	1-247-107-00	CARBON	100	5%	1/4W F
R365	1-246-473-00	CARBON	1K	5%	1/4W
R366	1-246-467-00	CARBON	560	5%	1/4W
R367	1-247-105-00	CARBON	82	5%	1/4W F
R368	1-247-107-00	CARBON	100	5%	1/4W F
R369	1-246-502-00	CARBON	16K	5%	1/4W
R370	1-246-501-00	CARBON	15K	5%	1/4W
R371	1-246-505-00	CARBON	22K	5%	1/4W
R372	1-247-107-00	CARBON	100	5%	1/4W F
R373	1-247-107-00	CARBON	100	5%	1/4W F
R374	1-246-501-00	CARBON	15K	5%	1/4W
R375	1-247-143-00	CARBON	3.3K	5%	1/4W F
R376	1-247-131-00	CARBON	1K	5%	1/4W F
R377	1-247-131-00	CARBON	1K	5%	1/4W F
R378	1-247-138-00	CARBON	2K	5%	1/4W F
R379	1-247-079-00	CARBON	4.7	5%	1/4W F
R380	1-247-079-00	CARBON	4.7	5%	1/4W F
R381	1-217-611-00	RES, METAL PLATE 0.1			
R382	1-217-611-00	RES, METAL PLATE 0.1			
R383	1-247-123-00	CARBON	470	5%	1/4W F
R384	1-246-517-00	CARBON	68K	5%	1/4W
R385	1-246-513-00	CARBON	47K	5%	1/4W
R386	1-247-192-00	CARBON	10	5%	1/2W F
R387	1-247-228-00	CARBON	330	5%	1/2W F
R388	1-246-545-00	CARBON	1M	5%	1/4W
R401	1-206-717-00	METAL OXIDE	470	5%	3W F
R402	1-246-473-00	CARBON	1K	5%	1/4W
R403	1-246-494-00	CARBON	7.5K	5%	1/4W
R404	1-246-494-00	CARBON	7.5K	5%	1/4W
R405	1-246-494-00	CARBON	7.5K	5%	1/4W
R406	1-246-501-00	CARBON	15K	5%	1/4W
R407	1-246-500-00	CARBON	13K	5%	1/4W
R408	1-246-473-00	CARBON	1K	5%	1/4W
R409	1-206-717-00	METAL OXIDE	470	5%	3W F
R501	1-247-079-00	CARBON	4.7	5%	1/4W F
R502	1-246-501-00	CARBON	15K	5%	1/4W

NOTE:

- Items with no part number and no description are not stocked because they are seldom required for routine service.
- Items marked "▲" are not stocked since they are seldom required for routine service. Some delay should be anticipated when ordering these items.
- Due to standardization, parts with part numbers (Δ-ΔΔΔ-ΔΔΔ-XX or Δ-ΔΔΔΔ-ΔΔΔ-X) may be different from those used in the set.

CAPACITORS:

MF:μF, PF:μμF.

RESISTORS

- All resistors are in ohms.
- F : nonflammable

COILS

- MMH : mH, UH : μH

SEMICONDUCTORS

In each case, U : μ, for example:
 UA...: μA..., UPA...: μPA..., UPC...: μPC,
 UPD...: μPD...

The components identified by shading and mark ▲ are critical for safety. Replace only with part number specified.

TA-AX500

ELECTRICAL PARTS

Ref.No.	Part No.	Description				
R503	1-246-477-00	CARBON	1.5K	5%	1/4W	
R504	1-246-489-00	CARBON	4.7K	5%	1/4W	
R505	1-246-529-00	CARBON	220K	5%	1/4W	
R506	1-246-521-00	CARBON	100K	5%	1/4W	
R507	1-246-544-00	CARBON	910K	5%	1/4W	
R508	1-246-521-00	CARBON	100K	5%	1/4W	
R509	1-206-662-00	METAL OXIDE	820	5%	2W	F
R601	1-246-458-00	CARBON	240	5%	1/4W	
R602	1-246-458-00	CARBON	240	5%	1/4W	
R603	1-246-458-00	CARBON	240	5%	1/4W	
R604	1-246-466-00	CARBON	510	5%	1/4W	
R701	1-244-817-00	CARBON	4.7	5%	1/2W	
R702	1-213-139-00	METAL OXIDE	470	5%	1W	F
R751	1-244-817-00	CARBON	4.7	5%	1/2W	
R752	1-213-139-00	METAL OXIDE	470	5%	1W	F
R801	1-244-825-00	(G-AEP)...CARBON	10	5%	1/2W	
R802	1-244-825-00	(G-AEP)...CARBON	10	5%	1/2W	
R851	1-244-825-00	(G-AEP)...CARBON	10	5%	1/2W	
R852	1-244-825-00	(G-AEP)...CARBON	10	5%	1/2W	
RT201	1-226-233-00	RES, ADJ, CARBON 1K				
RT251	1-226-233-00	RES, ADJ, CARBON 1K				
RT301	1-226-232-00	RES, ADJ, CARBON 500				
RT351	1-226-232-00	RES, ADJ, CARBON 500				
RV201	1-230-131-00	RES, VAR, CARBON 50K/50K, BALANCE/L				
RV202	1-230-130-00	RES, VAR, CARBON 10K/10K, ATTENUATOR/L				
RV251	1-230-131-00	RES, VAR, CARBON 50K/50K, BALANCE/R				
RV252	1-230-130-00	RES, VAR, CARBON 10K/10K ATTENUATOR/R				
RV301	1-230-132-00	RES, VAR, CARBON 24.5K/24.5K, BASS/L				
RV302	1-230-133-00	RES, VAR, CARBON 37.2K/37.2K, TREBLE/L				
RV351	1-230-132-00	RES, VAR, CARBON 24.5K/24.5K, BASS/R				
RV352	1-230-133-00	RES, VAR, CARBON 37.2K/37.2K, TREBLE/R				
RY701	1-515-501-00	RELAY				

ELECTRICAL PARTS

Ref.No.	Part No.	Description
S1	1-553-780-00	SWITCH, SLIDE (REMOTE), CARTRIDGE
S2	1-554-543-00	SWITCH, PUSH (5 KEY), PHONE
S3	1-554-543-00	SWITCH, PUSH (5 KEY), TUNER
S4	1-554-543-00	SWITCH, PUSH (5 KEY), CD
S5	1-554-543-00	SWITCH, PUSH (5 KEY), AUX
S6	1-554-543-00	SWITCH, PUSH (5 KEY), TAPE
S7	1-554-550-00	SWITCH, PUSH (REMOTE), CD DIRECT
S7	1-554-551-00	SWITCH, SLIDE (REMOTE), CD DIRECT
S8	1-554-547-00	SWITCH, PUSH, MONITOR
S9	1-554-548-00	SWITCH, PUSH, TAPE COPY 1-2
S10	1-554-546-00	SWITCH, ROTARY SLIDE, SPEAKERS
S11	1-554-544-00	SWITCH, PUSH (2 KEY), GRAPHIC EQUALIZER
S12	1-554-544-00	SWITCH, PUSH (2 KEY), SUBSONIC
S13	1-552-141-00	(AEP, G-AEP, UK, E)...SWITCH, PUSH, POWER
S13	1-552-246-00	(US)...SWITCH, PUSH, POWER
S14	1-526-576-31	(E)...SELECTOR, POWER VOLTAGE
T1	1-447-627-00	(US)...TRANSFORMER, POWER
T1	1-447-628-00	(AEP, G-AEP, UK)...TRANSFORMER, POWER
T1	1-447-629-00	(E)...TRANSFORMER, POWER
TM1	1-536-571-00	TERMINAL BOARD, 4P
TM2	1-536-571-00	TERMINAL BOARD, 4P

NOTE:

- Items with no part number and no description are not stocked because they are seldom required for routine service.
- Items marked "▲" are not stocked since they are seldom required for routine service. Some delay should be anticipated when ordering these items.
- Due to standardization, parts with part numbers (Δ-ΔΔΔ-ΔΔΔ-XX or Δ-ΔΔΔΔ-ΔΔΔ-X) may be different from those used in the set.

CAPACITORS:

MF: μF, PF: μμF.

RESISTORS

All resistors are in ohms.

F: nonflammable

COILS

MMH: mH, UH: μH

SEMICONDUCTORS

In each case, U: μ, for example:

UA...: μA..., UPA...: μPA..., UPC...: μPC,

UPD...: μPD...

The components identified by shading and mark ▲ are critical for safety. Replace only with part number specified.